

MOTOPLASTIC, S.A.

Molí de la sal, 1 - 08400 Granollers (Barcelona) SPAIN

Tel. 34 93 849 06 33 - Fax 34 93 849 09 88

info@motoplastic.com









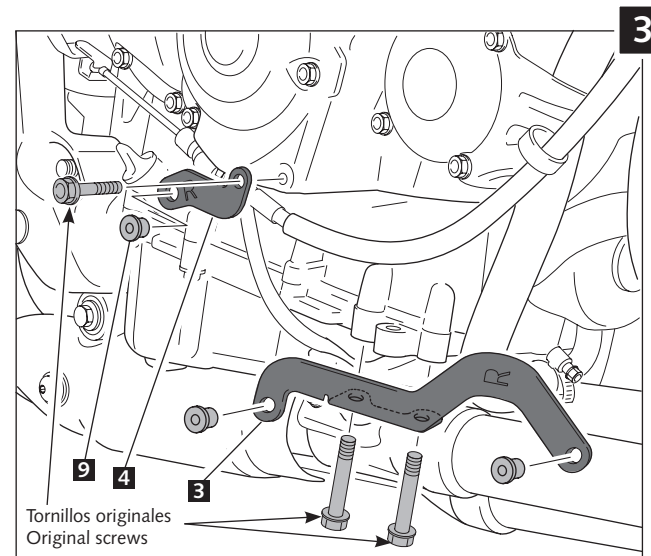
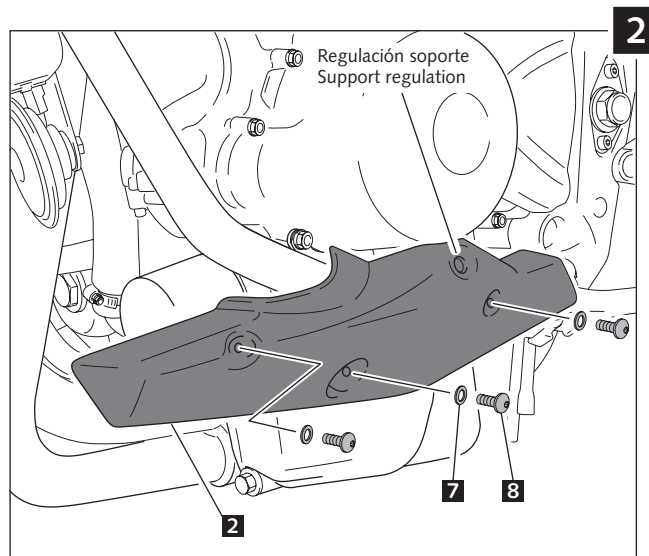
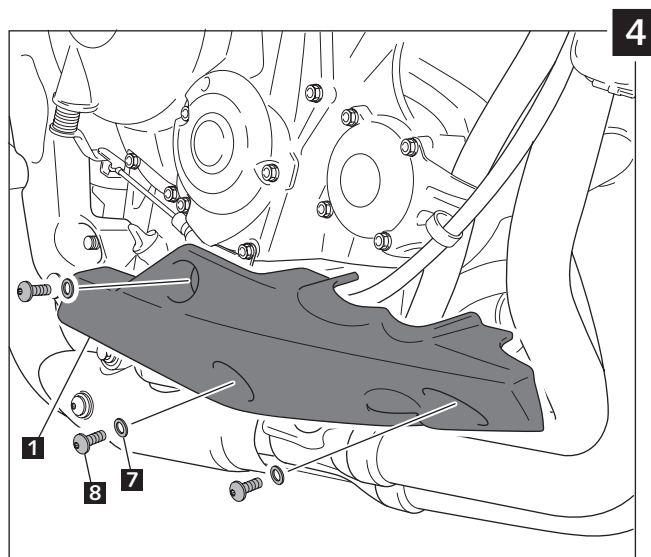
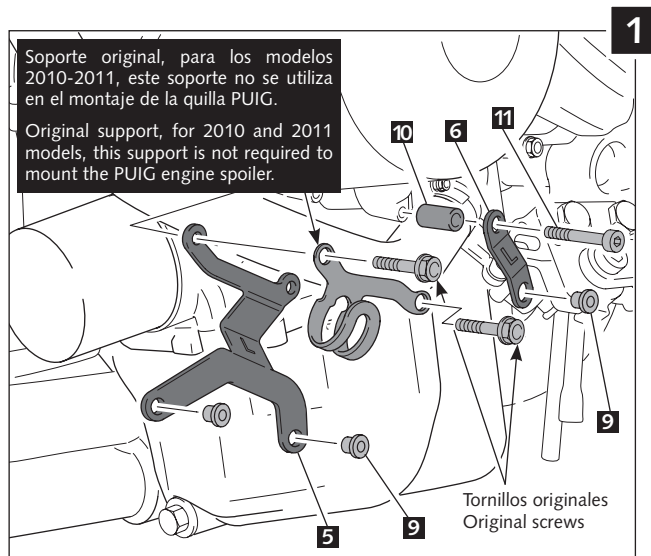

www.puig.tv

INSTRUCCIONES DE MONTAJE - MOUNTING INSTRUCTIONS

QUILLA ADAPTABLE A - ENGINE SPOILER ADAPTABLE TO TRIUMPH STREET TRIPLE 07'-12' / R 09'-12'

Ref.: 4702N
(color negro/black colour)
Ref.: 4702C
(color carbono/carbón look)



ID.	DESCRIPCIÓN	DESCRIPTION	QTY.
1	 Quilla derecha	Right engine spoiler	1
2	 Quilla izquierda	Left engine spoiler	1
3	 Soporte metálico derecho	Right metal support	1
4	 Soporte metálico derecho	Right metal support	1
5	 Soporte metálico izquierdo	Left metal support	1
6	 Soporte metálico izquierdo	Left metal support	1
7	 Arandela nylon Ø5	Nylon washer Ø5	6
8	 Tornillo allen M5x16 DIN 1001	M5x16 DIN 1001 allen screw	6
9	 Tuerca M5 con silemblock incorporado	M5 nut incorporated well nut	6
10	 Casquillo Ø int 6,5 x Ø ext 12x35	Arrowhead Ø inner 6,5 x Ø outer 12x35	1
11	 Tornillo allen M6x60 DIN 912	M6x60 DIN 912 allen screw	1